

Article number: 20908STM482A

Description: E+G Threaded plug DIN 908-ST-M48x2-A

Measures

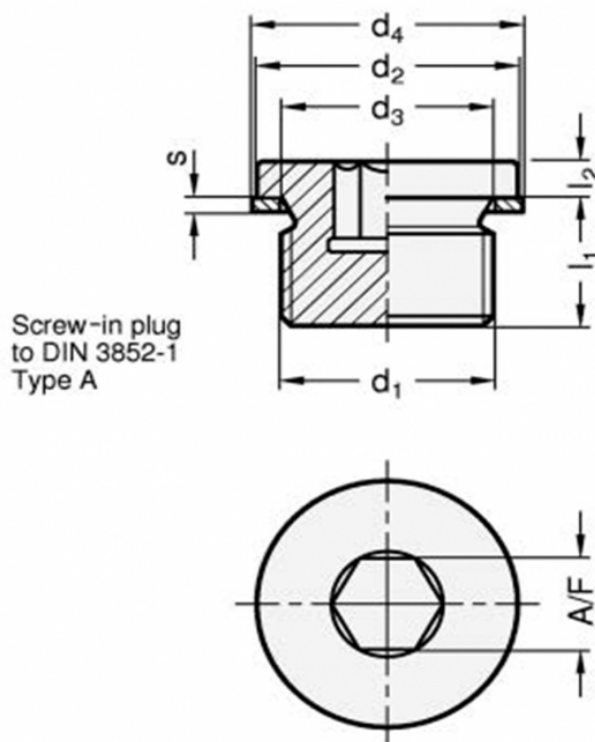

A/F	= 24
d1	= M48x2
d2h14	= 55
d3	= 48.3
d4	= 55
l1	= 16
l2	= 5
s	= 2

Weight in (g) = 240